

Using the I²C Interface on the ATmega328P

by

Allan G. Weber

1 Introduction

This document is intended for students in EE109L (Introduction to Embedded Systems) and EE459Lx (Embedded Systems Design Laboratory) and is meant to serve the following purposes.

- An introduction to the I²C protocol.
- A description of how to use the “i2c_io” C function for I²C data transfers.
- A short tutorial on how to configure the oscilloscopes in the labs for debugging I²C data transfers.

The I²C or I2C (Inter-Integrated Circuit) interface is a serial bus intended for communication between two or more integrated circuits on the same PC or prototyping board. Also known as a “two-wire bus”, this bus is for communication with many different types of IC’s such as EEPROMs, real-time clock, temperature sensors, etc. The I²C interface is not particularly fast so it is typically used for connecting to IC’s that do not require large amounts of data to be transferred rapidly.

Some of the microcontrollers used in EE109L and EE459Lx such as the Atmel ATmega328P implement this interface in hardware. The Atmel documentation calls the I²C interface the “Two Wire Interface” but it’s the same thing.

The hardware on microcontrollers like the ATmega328P perform many of the lower level tasks required for transferring data on the I²C bus. For example, to write data to a I²C device, the program sets up the transfer, starts it, keeps a data buffer full with the next byte to be sent and finally terminates the transfer at the end. The signaling required for sending each bit is handled by the hardware. Reading is done in a similar manner.

Software-only implementations of the I²C protocol can also be used to provide this interface on microcontrollers that do not have I²C hardware.

The Agilent and Tektronix oscilloscopes in OHE 240 and the Keysight scopes in VHE 205 lab have special triggering capabilities that make it possible to analyze I²C data transfers. Individual data transfers can be captured and viewed so that the transfer can be examined in detail to see if the correct information is being sent or received. This capability of these scopes is an extremely useful tool for students trying to debug any I²C aspects of their projects.

2 The I²C Bus

I²C devices communicate over a shared two wire bus. One wire is for the clock signal and the other is for the data. In our typical configurations, the microcontroller is the bus master and generates the clock signal. Depending on which way the data is being transferred, either the bus master (the microcontroller) or one of the slave devices generates the signal that is placed on the bi-directional data line. Figure 1 show a typical configuration with a microcontroller attached to three different devices (an EEPROM, a real-time-clock and a temperate sensor) by an I²C bus.

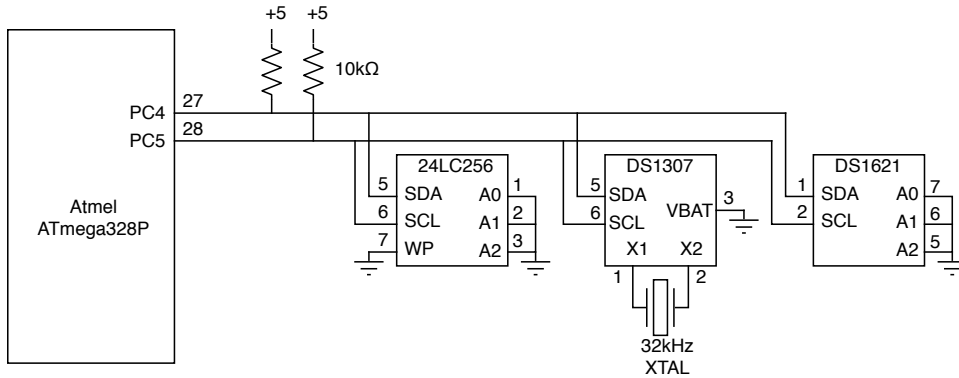

Figure 1: Typical I²C bus

To allow multiple devices to share the same bus, all the I²C devices attached to the bus must use “open drain” connections to both the clock and data lines. A device that needs to transfer data can either pull the line to ground (logical zero), or let it float in which case it will be pulled up to the power supply voltage (logical one) by the attached pull-up resistor. The pull-up resistors are usually in the range of $5k\Omega$ to $10k\Omega$ and one is needed for each of the two bus lines. **Note:** The internal pull-ups for the PC4 and PC5 I/O ports can not be used in place of the external pull-up resistors.

Important: An I²C bus will not operate without the pull-up resistors. When there is no activity on the bus, the clock and data lines must be in the high (logical one) state. If this is not the case, the data transfers can not be initiated. When debugging I²C hardware this is the first thing to check: are the clock and data lines high when no transfers are taking place? Both lines must be high before the transfer, and both must return to the high state after the transfer is complete.

3 I²C Devices and Data Transfers

The following sections describe how I²C devices are identified on an I²C bus and an overview of how writing and reading operations are performed.

3.1 Device Addresses

All devices attached to an I²C bus have an address that is used to identify the device on the bus. This is usually referred to as the “device address” and is fixed by the manufacturer of the device. In many cases it can not be changed by the user although some devices allow it to be customized slightly as described below. In order to use the I²C interface you need to know the address of the device on the I²C bus.

The specification of the address is a common source of confusion since some datasheets list it as a seven-bit number and others as an eight-bit number. The actual address is a seven bit number but it is often combined with an additional bit in the least significant bit position to create an eight-bit number. The upper seven bits are the address and the least significant bit indicates whether a read or write is occurring. An example of this is shown in Fig. 2. An I²C chip might have a seven-bit address of $0x5C$, but this can also be listed as the eight-bit address $0xB8$.

When searching for the address in the manufacturer’s datasheets it’s very important to figure out which format they are using for the address. Often the datasheet will not explicitly state that the address is the seven or eight bit address. In these cases the only solution may be to try both addresses in the software and see which one appears to work. Table 1 shows the 8-bit value (7-bit address + R/W flag) for some common devices used in projects.

Some I²C devices allow you to specify one or more of the least significant bits of the seven-bit address by connecting pins on the chip to a logical zero or one. This make it possible to have more than one device

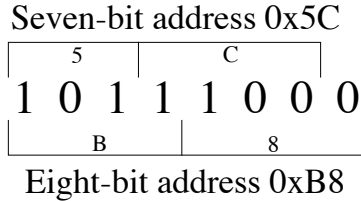

Figure 2: 7-bit and 8-bit I²C addresses

of the same type on the bus or to avoid address conflicts with other devices. The number of extra address bits available is indicated in Table 1.

I ² C Device	Description	8-bit Device Address	Number of Extra Address Bits
24LC256	32KB EEPROM	0xA0	3
DS1307	Real-time clock	0xD0	none
PCF8563	Real-time clock	0xA2	none
DS1621, DS1631	Temperature sensor	0x90	3
MCP23008	8-bit port expander	0x40	3
MCP23017	16-bit port expander	0x40	3
MAX7311	16-bit port expander	0x40	3
HMC5883L	Magnetic sensor	0x3C	none
MPL3115A2	Altimeter/thermometer	0xC0	none
LIS3DH	Accelerometer	0x30	none
MAX517	Digital-to-analog converter	0x58	2
NHD-0420D3Z-NSW-BBW	LCD display	0x50	none
TSL2591	Light sensor	0x52	none
DHT20	Temperature/humidity sensor	0x70	none
TCA9548A	8-channel I ² C switch	0xE0	3

Table 1: I²C 8-bit Device Addresses

3.2 Writing Data

Writing to an I²C device is usually done in two steps but these can normally be done as one single write operation. Many I²C devices consist of a number of registers or memory locations that can be written to and the first step is to send the address of the first location in the device that data is to be written to. The second part of the write operation is to send the data that goes in the addressed location. Most I²C devices will automatically increment the internal address after each byte is written to it, so it's only necessary to address the first location and all the data then written to it will be stored in consecutive locations.

For example, to write the bytes 0xAA, 0xBB and 0xCC to location 5, 6 and 7 in a device, the program would send the data: 0x05, 0xAA, 0xBB, 0xCC. The 0xAA will be stored in location 5, the 0xBB in location 6, and the 0xCC in location 7.

Some devices that have a large number of internal memory locations may require sending a two-byte address instead of a one-byte address as shown in the example above. In this case the operation is the same except two bytes of address data must precede the byte to be written.

This concept of the device's internal addresses is often a source of confusion for users. It's important to understand the difference between the "device address" that identifies the I²C device on the bus, and the "internal address" that specifies where in the device data will be written to (or read from.)

3.3 Reading Data

Many I²C devices require reading operations to be done in two steps. The first part of the reading operation consists of a write operation as described above where the address of the first location to be read is sent to the device. Depending on the device this might be a single address byte or it could be multiple bytes. However instead of then sending the data to be written starting at that location, the write operation is terminated and a read command is sent. This causes the device to start sending data from the location given by the address data that was previously written to it. As with a write operation, the internal address is automatically incremented as data is read and the program can read as many consecutive locations as needed.

4 Initializing the I²C Modules

4.1 ATmega328P

The ATmega328P uses pins 27 and 28 for the I²C data and clock. When I²C is not used these pins can be used as general I/O ports PC4 and PC5.

The internal I²C hardware needs to have the baud rate (I²C clock rate) set before any transfers can take place. The maximum rate that the I²C device can handle should be described in the device's datasheet, but most devices should be able to operate with a clock up to 100kHz. The clock is derived from the microcontroller's clock by dividing it down according to this formula.

$$\text{I}^2\text{C Baud Rate} = \frac{\text{CPU Clock Frequency}}{16 + 2(TWBR) \cdot (\text{prescalar value})}$$

The prescalar value is set by a two bit number in the TWSR register and can be either 1, 4, 16 or 64. The *TWBR* value is the eight-bit contents of the TWBR register. This value can be calculated if we rearrange the above formula to solve for *TWBR*

$$TWBR = \left(\frac{\text{CPU Clock Frequency}}{\text{I}^2\text{C Baud Rate}} \right) - 16) / (2 \cdot \text{prescalar value})$$

A suitable value for *TWBR* can be calculated in the program source code using compiler preprocessor statements. For example, assume the processor clock has a frequency of 9.8304MHz, and we want a I²C baud rate of no more than 100kHz. We can set the prescalar to one and then use the following to determine the value to go in the TWBR register.

```
#define FOSC 9830400          // Clock frequency = Oscillator freq.
#define BDIV (FOSC / 100000 - 16) / 2 + 1

TWSR = 0;                    // Set prescalar for 1
TWBR = BDIV;                 // Set bit rate register
```

The +1 at the end of the statement calculating BDIV is needed since the integer calculations done by the preprocessor could have truncation errors resulting in a value of BDIV that is too low and giving an I²C frequency over 100kHz. The +1 makes sure the frequency is below 100kHz.

The software provided for I²C on the ATmega328P includes function that can be called to do the initialization. The routine take the value to go into the bit rate register (BDIV in the example above) as its argument. The following is an example of how it can be used.

```
#define FOSC 9830400
#define BDIV (FOSC / 100000 - 16) / 2 + 1

i2c_init(BDIV)
```

5 Using the `i2c_io` I²C Interface Routine

A C function, `i2c_io`, has been written to hopefully simplify doing reads and writes to I²C devices. This function combines the operations of reading and writing into a single function since the nature of how reads and writes are done with I²C results in a lot of commonality between the operations.

The function interface is based on two arrays of bytes. The first array contains any data that is to be written to the device. The second array is where data read from the device is stored.

The function is called in the following manner.

```
status = i2c_io(DEV_ADDR, wbuf, nw, rbuf, nr);
```

where “`wbuf`” and “`rbuf`” are the two arrays, and “`nw`” and “`nr`” are the number bytes to write from or read in to each respectively. If the count value for either of the arrays is zero, nothing is written from or read into that array. The function return value is zero if there were no errors. A non-zero value indicate some type of error occurred.

The following code segment show how to write four bytes of data to a device at 8-bit I²C device address `0xAC` with the internal address for the write starting at 9.

```
unsigned char status;
unsigned char buf[5] = { 9, 1, 2, 3, 4 };

status = i2c_io(0xAC, buf, 5, NULL, 0);
```

The following code segment show how to read 32 bytes of data from a device at 8-bit I²C device address `0x70` with the internal address for starting the reading specified by the two byte value `0x0120`.

```
unsigned char status;
unsigned char wbuf = {0x01, 0x20};
unsigned char rbuf[32];

status = i2c_io(0x70, wbuf, 2, rbuf, 32);
```

For more information on using the `i2c_io` routine see the comments at the beginning of the function source code.

6 Viewing I²C Transfers on the Keysight MSO-X 3024A Scopes

The Keysight (ex-Agilent) MSO-X 3024A oscilloscopes have I²C triggering as part of the EMBD option. To make use of this follow the steps below. If at any time during the setup you want to make a menu disappear from the screen, press the “Back” button near the lower right corner of the screen.

1. Turn on the scope and then turn on two of four input channels by pressing the buttons with numbers on them in the vertical section of controls until the traces appear on the screen (Fig. 3). In this example we’ll use channels 1 and 2.
2. Use the large knobs above the “1” and “2” buttons to adjust the input levels for both channels to 5 Volts per division. The levels for the channels are shown in the upper left part of the screen.
3. Use the small knobs below channel buttons to vertically position the two traces on the screen where both can be viewed.
4. Use the large knob in the horizontal section of the controls to change the horizontal sweep speed to 200 μ s (time/division). The sweep speed is shown in the upper right portion of the screen.
5. The small knob in the right part of the horizontal section changes the horizontal position of the displayed signal. First press the knob to center the signal on the screen, and then rotate the knob to move the small orange triangle at the top of the screen over closer to the left side of the screen. When an I²C signal is captured, it will be displayed with the starting point of the signal at this position.
6. Connect two scope probes to channels 1 and 2 of the scope and then connect the probe tips to the I²C clock and data lines on your project board. Either one can be attached to either signal but make note of which way they are connected.
7. The Keysight scopes can have two stored configurations for working with serial signals like I²C. To setup a one for I²C, press the “Serial” button in right portion of the screen. This brings up the Serial Decode Menu along the bottom of the screen. Press the left soft key and it should show the two Serial selections. If Serial 1 doesn’t have the box next to it filled in with a blue square, press the button again to select it.
8. The label for the second softkey from the left shows the current protocol selection for the bus. If it doesn’t say “I²C”, press the softkey below the label to bring up a vertical menu for selecting the protocol type. Using the knob with the illuminated green arrow just to the right of the screen, select the “I²C” setting for Serial 1 as shown in Fig. 4.

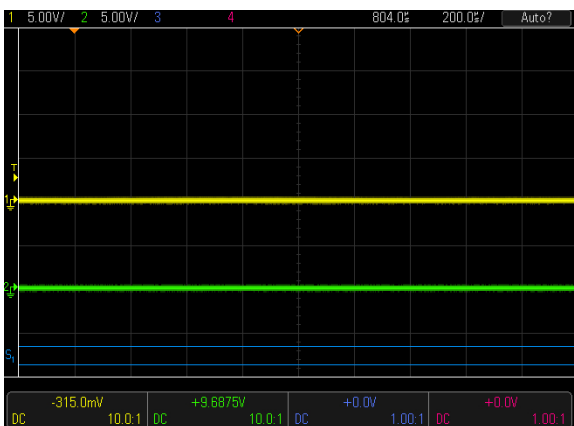

Figure 3: Keysight channel settings

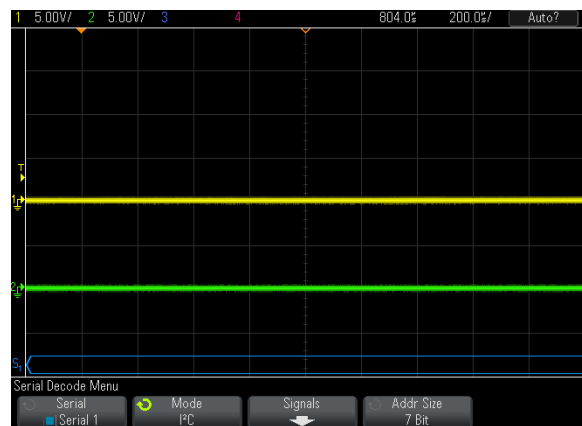

Figure 4: Keysight serial mode set for I²C

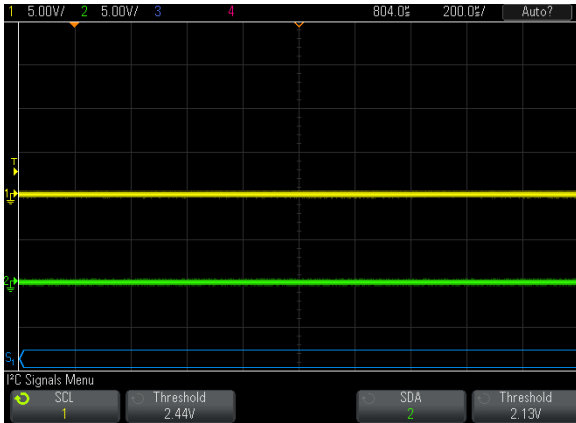

Figure 5: Keysight I²C input settings

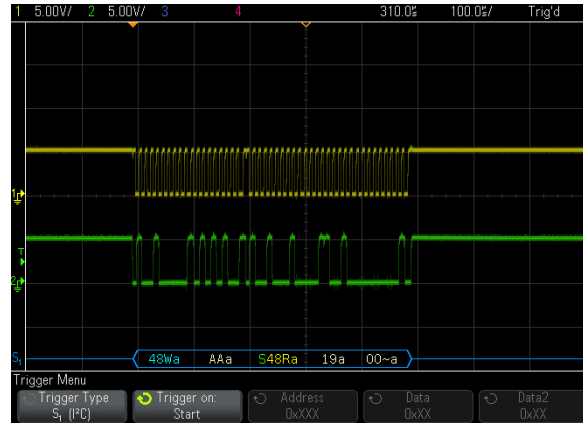

Figure 6: Keysight I²C signal display

9. Press the third softkey from the left labeled “Signals”. This brings up the screen shown in Fig. 5. The current settings for which channel is clock (SCL) and which is data (SDA) is shown along the bottom of the screen. Use the softkeys below the channel destinations and the selector knob to change these to match how you connected the probes to the hardware under test.
10. For each channel, press the “Threshold” softkeys and then use the selector knob to adjust the voltage thresholds. The thresholds need to be set to something around the middle of the zero to 5 volt range. Use the selector knob to set each of the thresholds to 2.4 to 2.6 Volts
11. Press the “Trigger” button in the Trigger section of the controls. Press the “Trigger Type” soft key to bring up the vertical menu of triggering types, and use the selector knob to scroll down near the bottom and select “Serial 1”.
12. The “Trigger on:” softkey is used to select the I²C condition that will cause the scope to acquire data. For most purposes a “Start” condition works best. If the softkey doesn’t say “Start”, press it to bring up the “Trigger on:” menu and use the selector knob to set it for triggering on an I²C Start condition.
13. Press the “Mode/Coupling” button in the Triggers section of the controls. Use the left softkey that says Mode to set the triggering mode to “Normal”.

At this point the scope is configured to trigger on a I²C Start condition. Press the “Single” button in the upper right to put the scope in a state where it will wait for the next Start condition on the I²C bus and then capture the data. Do whatever is needed on your project board to get it to generate the I²C transfer, and once the data has been captured it will be displayed on the screen (Fig. 6). The captured data can be expanded or shrunk horizontally using the horizontal scale control. The smaller knob in the horizontal section can be used to move the display left or right to see all parts of the I²C data.

The bottom portion of the screen should show the contents of each byte in the the I²C transfer in hexadecimal. In addition it will mark various protocol bits in the transfer: S = Start, R = read, W = write, a = ACK.

7 Viewing I²C Transfers on the Tektronix DPO2014/MSO2014 Scopes

The Tektronix DPO2014 and MSO2014 oscilloscopes have I²C triggering as part of the DPO2EMBD option. To make use of this follow the steps below. If at any time during the setup you want to make a menu disappear from the screen, press the “Menu Off” button near the lower right corner of the screen.

1. Turn on the scope and then turn on two of four input channels by pressing the buttons with numbers on them in the vertical section of controls until the traces appear on the screen. In this example we'll use channels 1 and 2. The wide rectangular box at the lower left of the screen (Fig. 7) shows the channels that have been turned on.
2. Use the large “Scale” knobs below the “1” and “2” buttons to adjust the input levels for both channels to 5 Volts per division. The levels for the channels are shown in the lower left part of the screen.
3. Use the small knobs above channel buttons to vertically position the two traces on the screen where both can be viewed.
4. Use the large knob in the horizontal section of the controls to change the horizontal sweep speed to 200 μ s (time/division). The sweep speed is shown in the box in the lower center portion of the screen.
5. The small “Position” knob in the horizontal section changes the horizontal position of the displayed signal. Use this knob to move one of the small “T” markers near the top of the screen over closer to the left side of the screen. When an I²C signal is captured, it will be displayed with the starting point of the signal at this position.
6. Connect two scope probes to channels 1 and 2 of the scope and then connect the probe tips to the I²C clock and data lines on your project board. Either one can be attached to either signal but make note of which way they are connected.
7. The Tek scopes can have two configurations stored for working with buses. To setup a bus for I²C, press one of the “B1” or “B2” buttons just above the connector of channel 1. In this example we'll use Bus 1. Pressing the B1 button brings up the bus configuration menu along the bottom of the screen.
8. The label for the left softkey shows the current setting for the bus. If it doesn't say “Bus B1 I2C”, press the softkey below the label to bring up a vertical menu for selecting the bus type (Fig. 8). Using the “Multipurpose (a)” knob in the top left part of the controls, select the “I2C” setting for bus B1.
9. Press the second softkey from the left labeled “Define Inputs”. This brings up the screen shown in Fig. 9. The current settings for which channel is clock and which is data is shown at the right side of the screen. Use the (a) and (b) Multipurpose knobs to change these to match how you connected the probes to the hardware under test.
10. Press the “Thresholds” softkey to see the voltages threshold settings for each channel. The thresholds need to be set to something around the middle of the zero to 5 volt range. Use the two Multipurpose controls to set each of the thresholds to 2.4 or 2.6 Volts
11. Use the “Include R/W in address” softkey to change that setting to “Yes”. This will make the scope display the device addresses as a eight-bit number with the least significant bit representing the read/write flag.
12. Use the “Bus Display” softkey to change that setting to “Hex”. This causes the bytes of data on the bus to be displayed in hexadecimal rather than as binary numbers.
13. Press the “Menu” button in the Trigger section. If the “Type” softkey label doesn't say “Bus”, press it and use the Multipurpose (a) knob to scroll down to “Bus”.
14. The “Trigger On” softkey is used to select the I²C condition that will cause the scope to acquire data. For most purposes a “Start” condition works best. If the softkey doesn't say “Start”, press the softkey to bring up the “Trigger On” menu (Fig. 10) and use the Multipurpose (a) knob to set it for triggering on a I²C Start condition.



Figure 7: Tek channel settings

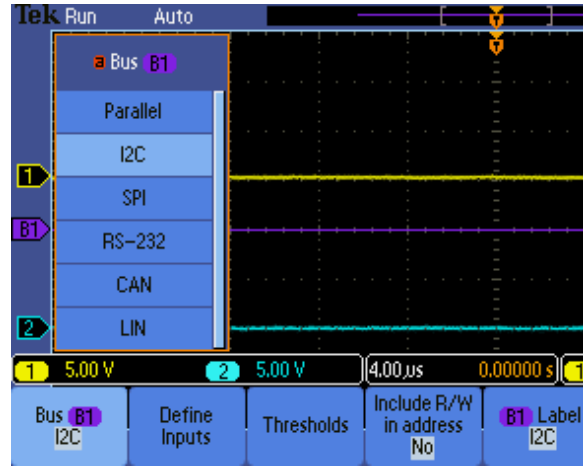

Figure 8: Tek bus configuration

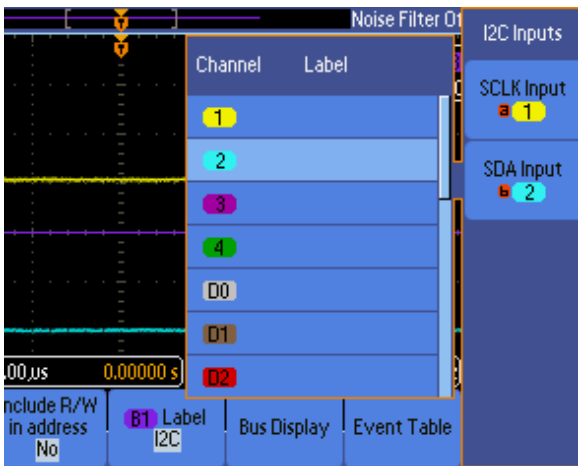

Figure 9: Tek channel selection

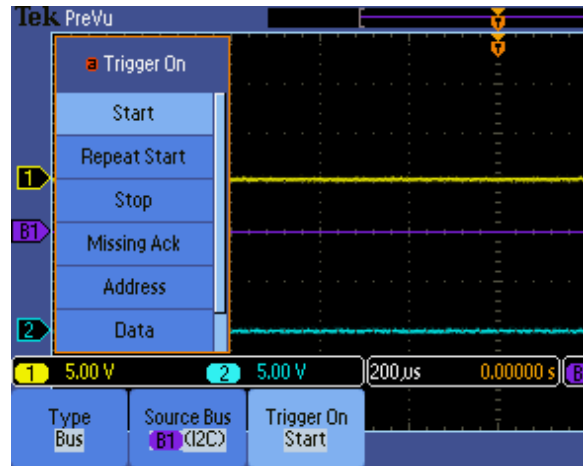

Figure 10: Tek trigger conditions

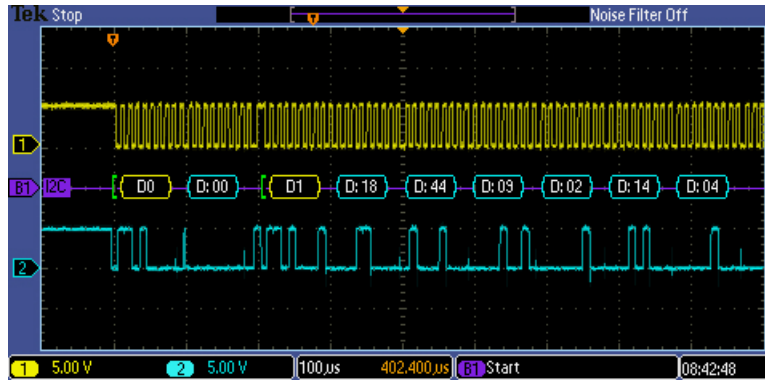

Figure 11: Tektronix I²C signal display

15. If the right softkey along the bottom doesn't say "Mode Normal . . .", press it and then press the softkey along the right side to set the trigger mode for "Normal".
16. If needed press "Menu Off" a few times to remove the menus from the screen.

At this point the scope is configured to trigger on a I²C Start condition. Press the "Single" button above the triggering controls to put the scope in a state where it will wait for the next Start condition on the I²C bus and then capture the data. Do whatever is needed on your project board to get it to generate the I²C transfer, and once the data has been captured it will be displayed on the screen (Fig. 11). The captured data can be expanded or shrunk horizontally using the smaller inner knob of the "Wave Inspector" control in the top middle portion of the front panel. To scroll the data left or right, use the larger outer part of this control.

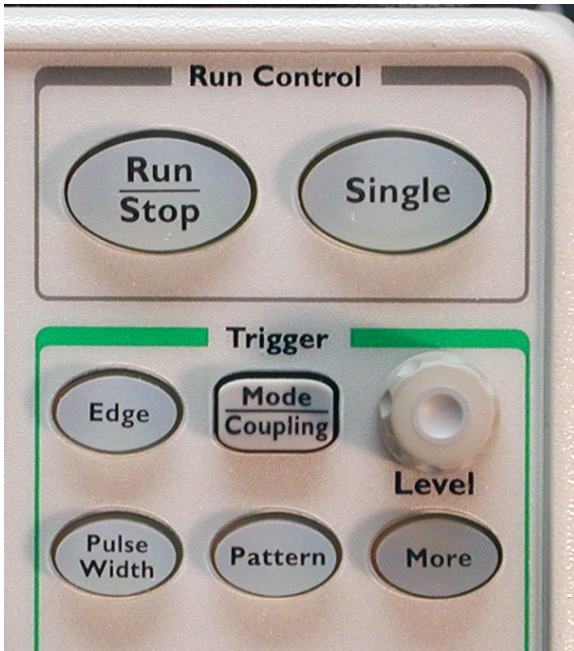

Figure 12: Agilent triggering controls

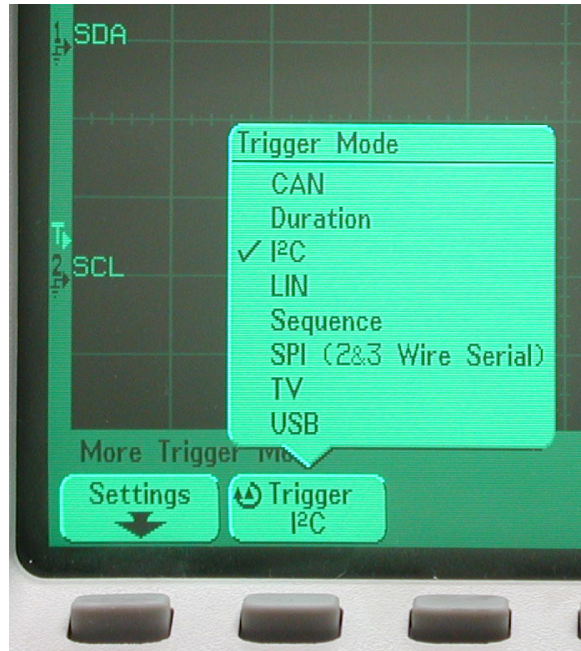

Figure 13: Agilent trigger Mode menu

8 Viewing I²C Transfers on the Agilent 54622A Scopes

The Agilent 54622A oscilloscopes have I²C triggering built in to them. To make use of this follow the steps below.

1. Turn on the scope and then turn on both input channels by pressing the “1” and “2” buttons in the vertical section of controls until they light up.
2. Use the large knobs above the “1” and “2” buttons to adjust the input levels for both channels to 5 Volts per division. The levels for the channels are shown in the top left corner of the screen.
3. Use the large knob in the horizontal section of the controls to change the horizontal sweep speed to 200 μ sec/div. The sweep speed is shown in the top center portion of the screen.
4. The small knob in the horizontal section changes the horizontal position of the displayed signal. Use this knob to move one of the small triangles near the top of the screen over closer to the left side of the screen. When an I²C signal is captured, it will be displayed with the starting point of the signal at this position.
5. In the trigger section of the controls (Fig. 12), press the “Edge” button.
6. Press the softkey below the screen for channel 1, and then use the “Level” knob in the triggering section to adjust the trigger voltage to around 2.5 Volts. The trigger voltage level is indicated in the top right corner of the screen. Press the softkey for channel 2 and set the channel 2 trigger level to around 2.5 Volts.
7. In the trigger section of the controls, press the “Mode/Coupling” button.
8. If the left softkey doesn’t say “Mode Normal”, press it to bring up the mode menu and press it again until “Normal” is selected.

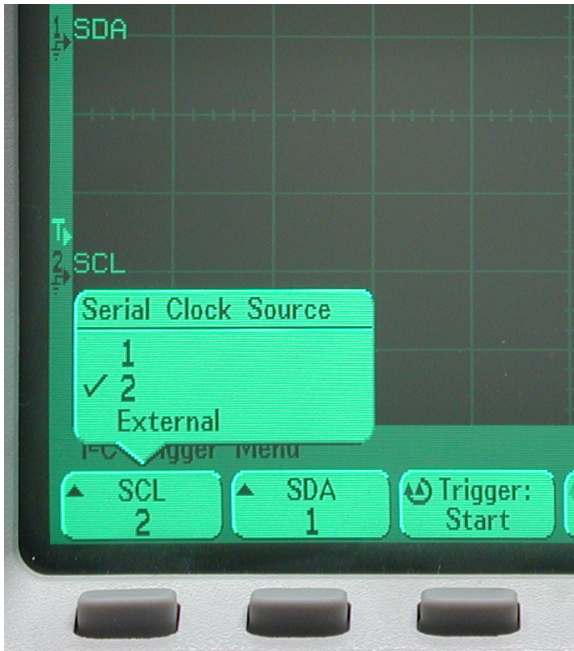

Figure 14: Agilent channel selection

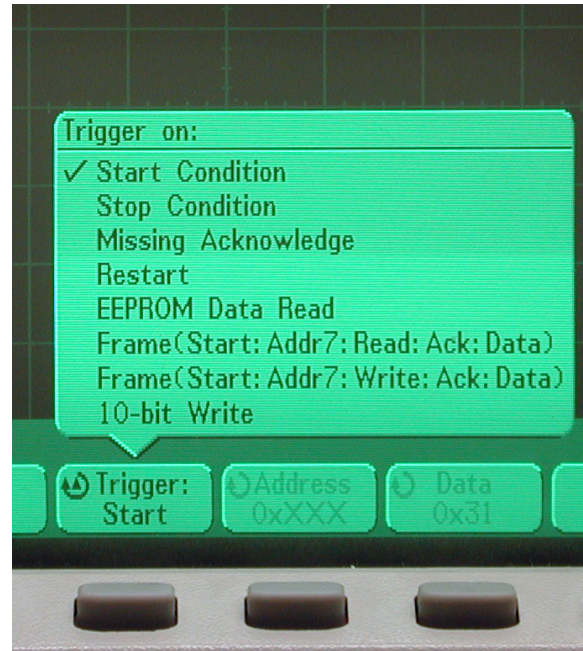

Figure 15: Agilent trigger conditions

9. Connect the two scope probes to scope and then connect the probe tips to the I²C clock and data lines on your project board. Either one can be attached to either signal but make note of which way they are connected.
10. In the triggering section of the scope controls, press the "More" button.
11. If the label of the second softkey does not say "Trigger I²C", press this button to bring up the trigger mode menu (Fig. 13) and then continue pressing it until the check mark is by I²C.
12. Press the left softkey that is labeled "Settings" to bring up the "I²C Trigger Menu" screen
13. The labels on two left most softkeys indicate which channel is assigned to the I²C clock and which is for the data (Fig. 14). If the channel assignment is opposite to how you connected the probes, press either of the two softkeys for the channel assignments. This will bring up a menu for the channel assignment and you can press that key again until the setting is correct. You don't need to change both channels manually since changing one causes the other to also change.
14. Check the label on the third softkey to make sure it says "Trigger: Start". If it doesn't, press this key to bring up the "Trigger on:" menu (Fig. 15) and then press the button enough times to select "Start condition".

At this point the scope is configured to trigger on a I²C Start condition. Press the "Single" button above the triggering controls to put the scope in a state where it will wait for the next Start condition on the I²C bus and then capture the data. Do whatever is needed on your project board to get it to generate the I²C transfer, and once the data has been captured it will be displayed on the screen. The captured data can be expanded or shrunk horizontally using the large knob in the horizontal section of controls. To scroll the data left or right, use the small knob in the horizontal section.